

Varenummer: 204801V16250ALOS

Beskrivelse: E+G Firkantrør uden scala - GN 480.1-V16-250-AL-OS

Mål

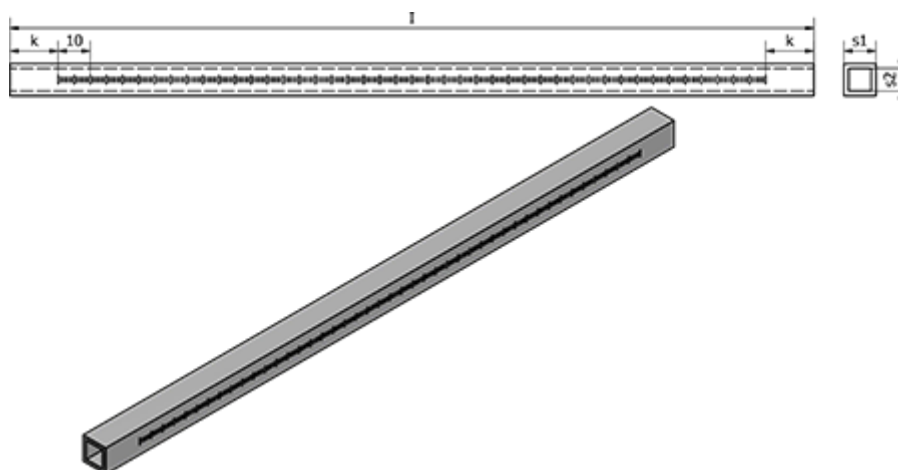

l	= 250
k	= 20
s1	= V16
s2	= 13
Vægt (g)	= 53